

Qq

キュー

Q

q

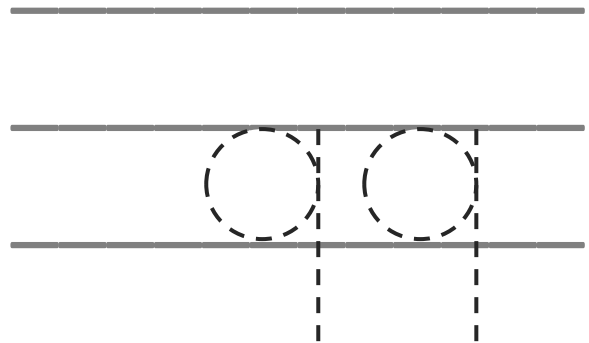
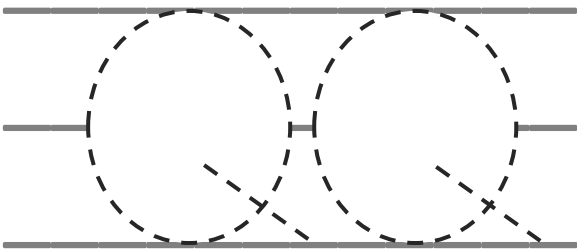
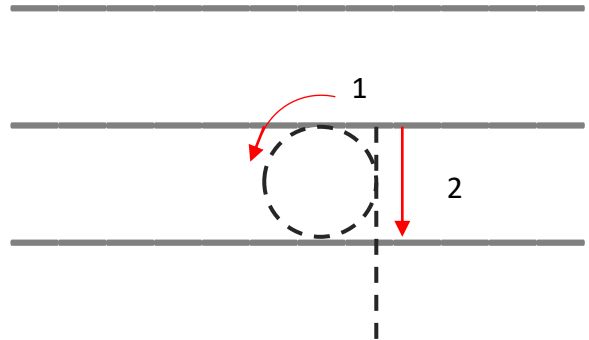
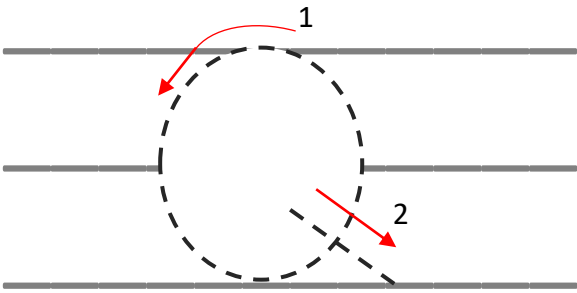

1 Words that start with Qq

キューからはじまることば



quail



queen

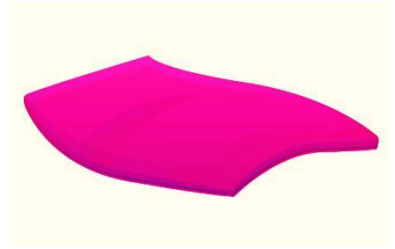

quilt



quay



question









quiz

2 Letter Match

Circle the picture that begins with the **q** sound.

キューのおとからはじまるえをまるでかこみましょう

<p>q</p>	<div style="display: flex; justify-content: space-around; align-items: center;">  <div style="text-align: center;"> <p>rainbow question</p> </div>  </div>
<p>q</p>	<div style="display: flex; justify-content: space-around; align-items: center;">  <div style="text-align: center;"> <p>quail</p> </div>  <div style="text-align: center;"> <p>rat</p> </div> </div>
<p>q</p>	<div style="display: flex; justify-content: space-around; align-items: center;">  <div style="text-align: center;"> <p>queen</p> </div>  <div style="text-align: center;"> <p>Rapunzel</p> </div> </div>

3 Let's Practice!

れんしゅうしましょう

Qq is for quail.



Qq is for quay.



Qq is for queen.



Qq is for question.



Qq is for quilt.



Qq is for quiz.



4 Find the secret letter!

Color the letter Q.

キューをぬりつぶしましょう

R	P	P	P	Q	Q	Q	Q	Q	Q	Q	Q	O	O	O	O	R
R	R	P	Q	Q	Q	Q	Q	Q	Q	Q	Q	Q	O	O	O	R
R	R	P	Q	Q	Q	Q	Q	Q	Q	Q	Q	Q	O	O	O	R
R	R	P	Q	Q	Q	P	O	O	O	Q	Q	Q	O	O	O	R
R	R	P	Q	Q	Q	P	P	P	P	Q	Q	Q	O	O	O	R
R	R	P	Q	Q	Q	P	R	R	R	Q	Q	Q	O	O	O	R
R	R	P	Q	Q	Q	P	O	O	O	Q	Q	Q	P	P	O	R
R	R	P	Q	Q	Q	P	O	O	O	Q	Q	Q	O	O	P	R
P	P	P	Q	Q	Q	P	Q	Q	Q	Q	Q	Q	O	O	P	R
P	P	P	Q	Q	Q	P	O	Q	Q	Q	Q	Q	P	P	O	R
P	P	P	Q	Q	Q	Q	Q	Q	Q	Q	Q	Q	R	R	R	R
P	P	P	Q	Q	Q	Q	Q	Q	Q	Q	Q	Q	R	O	O	R
P	P	P	P	Q	Q	Q	Q	Q	Q	Q	Q	Q	Q	R	R	R
P	P	P	P	O	O	P	P	P	P	P	P	Q	Q	Q	P	P